



Welcome to the World of  
**E-Collar Technologies, Inc.**

---

# **Pro Educator PE-900**

## **Owner's Manual**

**“Happiness is a Well  
Behaved Dog”**

# Welcome to the World of E-Collar Training



## Pro Educator 900 Series E-Collar

Remote Education Collar

Dear valued customer,

Congratulations on the recent purchase of your E-Collar training system. We are confident that you will be pleased with the results achieved through the use of our e-collar training system. We have taken great care to incorporate numerous safety features to ensure a positive experience for both you and your dog.

To maximize your success, it is crucial to employ the lowest level of stimulation and approach the training process with patience and understanding. By applying gentle leash pressure and using a low level of stimulation, you will achieve the best outcomes. It is important for your dog to recognize the sensation from the stimulation as a means of communication, rather than something to be feared.

It is recommended that the use of our training system be incorporated into a comprehensive training program. We suggest taking the time to familiarize yourself with the features and functions of your E-Collar before placing the collar on your dog. Additionally, please consider subscribing to our YouTube and Facebook pages for educational resources on the proper use of e-collars.

We wish you the best of luck with your training endeavors and encourage you to reach out to us at any time for assistance.

This guide is designed to provide you with assistance on the fundamental functions, programming features, and contents of your E-Collar training system. For further information and support, please visit [www.ecollar.com](http://www.ecollar.com) or reach out to us at [customer-service@ecollar.com](mailto:customer-service@ecollar.com).

We encourage you to contact our esteemed customer service department for any inquiries you may have at (260) 357-0051.

# 02

## TABLE OF CONTENTS

---

- Important Notice	03
- Characteristics	04
- Package Contents	05
- Device Operation	06
- Charging the Batteries	07
- Turning Your E-Collar ON/OFF	08
- Correctly Fitting Collar	09
- The LCD Display Description	10
- Programing Stimulation Buttons	11
- Computer Interface Tool	12
- Instant Stimulation	13
- How to Find the Proper Stimulation Level	14
- Lock/Unlock the Stimulation Level	15
- Tracking Night Light	16
- How to Set the Boost	17
- Lost Transmitter Mode	18
- Replace/Add Collar	19

### Two Dog Specifics

- Multi Dog System	20
- 902/903 Button Functions	22
- 902/903 Lock/Unlock the Stimulation Level	23
- 902/903 Boost Level Setup	24
- Testing Your E-Collar	25
- Replacing the Contact Points	26
- Training Tip	27
- Troubleshooting	28
- Two Year Warranty	29
- Accessories	30
- Safety and General Information	31
- Important Notice	32
- Technical Specifications	33

## IMPORTANT NOTICE

---

This product is specifically designed for canine use only.

E-Collar Technologies, Inc. assumes no responsibility for any misuse of this product, including damages caused by dog bites and lost items. Before using this product on aggressive dogs, it is advised to seek an evaluation by a professional trainer. It is not uncommon for aggressive dogs to associate the stimulation with the handler and potentially act against them. In some cases, dogs that are subjected to e-collar pressure during a fight may display redirected aggression and become even more aggressive.

The use of high levels of stimulation should only be considered as a last resort and in life-threatening situations. To avoid unintentionally stimulating your dog, it is recommended to keep the stimulation level below 5 when the product is not in use.

The effective range of your E-Collar training device may be influenced by various factors such as terrain, weather conditions, presence of trees or power lines, and potential interference from other wireless devices. Positioning the transmitter for maximum range.

For optimal range, grasp the transmitter in a manner similar to holding a torch, such as the one held by the Statue of Liberty. Ensure that the antenna remains separate from your body and fingers at all times, as touching the antenna can significantly diminish the range.



[ Long Range ]



[ Medium Range ]



[ Short Range ]

# 04

## CHARACTERISTICS

---

- Range : 1/2 Mile
- Seven Stimulation Modes Supported  
Momentary, Momentary Boost, Continuous, Continuous Boost, 1 Second Ramp, 2 Second Ramp, Instant Stimulation
- Vibration: Alternative to Stimulation (gives a vibration similar to a Cell Phone)
- Tone : Flat audible sound for up to 30 seconds
- Computer interface tool: allows you to change the settings on your PE 900 series E-Collar, customizing it for your dog's specific needs. Vibration and Tone type can only be changed using the computer interface tool.
- Quick Charge Li-Polymer Batteries
- Convenient Intensity Dial for Quick Adjustment
- Stimulation Levels Adjustable from Oto 100
- Collar Receiver Light for locating your dog at night
- Lock and Set Stimulation Safety Feature
- User Adjustable Boosting Levels from 1 to 60 Levels
- Completely Water Resistant
- Convertible from 1-Dog model (900) to 2-Dog model (902) to 3-Dog (903)

# PACKAGE CONTENTS

---

- Ergonomic Transmitter
- Collar Receiver + Strap
- Owner's Manual

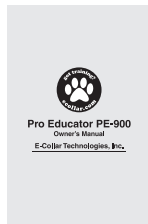
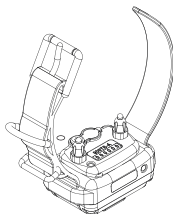
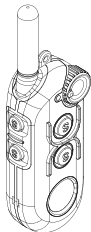

- Test Light
- Contact Point Tool
- 5/8" and 3/4" Contact Points

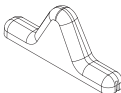

- Lanyard
- Battery Charger
- Metal Belt Clip

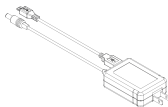

# 06

## DEVICE OPERATION

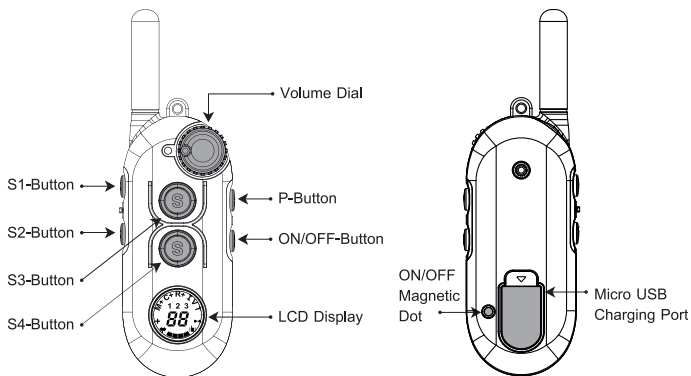

S1,S2,S3,S4	Programmable Stimulation Button
P Button	Programming mode Button
ON/OFF Button	Turn Device ON/OFF
Volume Dial	Change Stimulation Level

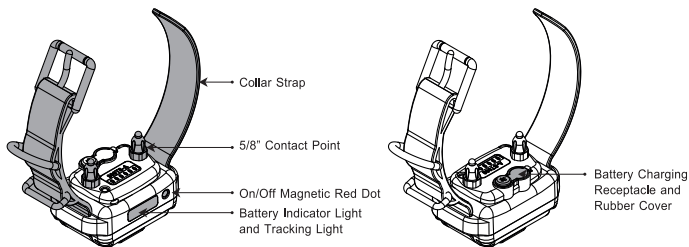

## CHARGING THE BATTERIES

Indicator Light is blinking "Green" under normal operation.  
 solid "Red" when stimulation is applied.  
 blinking "Red" when recharging is required.

**Do not allow the batteries to get hot or be fully discharged,  
 store at room temperature and 50% capacity charge,**

Transmitter Battery Charging Receptacle and Rubber Cover      Collar Receiver Battery Charging Receptacle and Rubber Cover

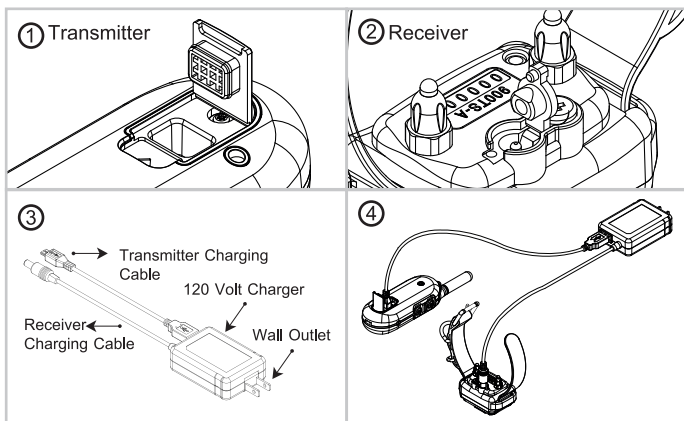

The indicator light will turn solid red during charge cycles and turn green if it is fully charged. (approximately 2 hours)

Your e-collar is equipped with Li-Polymer batteries that need specific attention to ensure their longevity. It is advisable to avoid fully discharging the battery. In the event of complete discharge, please recharge it promptly to prevent irreversible damage. Additionally, please keep the units away from excessive heat and cold temperatures.



# 08

## TURNING YOUR E-COLLAR ON/OFF

---

- To turn the Collar Receiver On or Off:  
Place the small red dot on the Transmitter to the small red dot on the Collar Receiver.

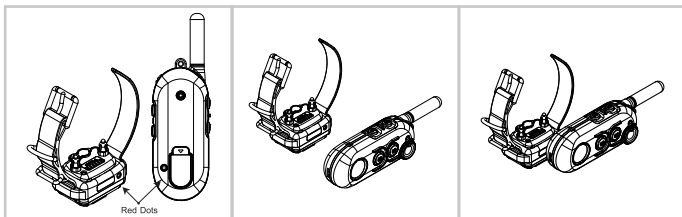

- To turn the Collar Receiver On or Off:

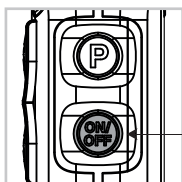

Press thr "ON/OFF Button" for more than 1 second

## CORRECTLY FITTING COLLAR

---

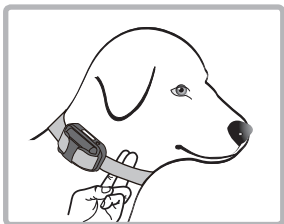

The collar should be adjusted to allow the "contact points" to have direct contact with the skin. You should be able to fit a couple of fingers between the collar strap and your dog's skin. Too tight poses the risk of skin irritation





and discomfort. Too loose and the contact points will not be able to administer the stimulation reliably and can cause skin irritation due to chafing. Short hair breeds may need the 3/8" microprobes offered as an accessory item, contact customer service for details. The optimal position for the collar receiver is on either side of the dog's windpipe. If the factory installed 5/8" contact points are not making good contact due to thick fur, see page 24 for changing contact points.

### IMPORTANT NOTICE

To prevent the occurrence of skin irritations the Collar Receiver should never be worn for more than 12 hours per day. Should your dog experience skin irritations from over exposure to the contact points remove the collar receiver unit immediately and stop using your e-collar until all skin irritations are completely healed. Antibiotic ointment will aid in the healing process. Some dog breeds have extra thick fur or extra short fur that requires special contact points. Please contact our customer service or visit [www.ecollar.com](http://www.ecollar.com) for more information.

# 10

## THE LCD DISPLAY DESCRIPTION

Icon	Description	Action
<b>M</b>	Momentary Stimulation	Send Single Stimulation in short duration
<b>M+</b>	Momentary Boost Stimulation	Send boosted single stimulation in short duration
<b>C</b>	Continuous Stimulation	Sends stimulation continuously up to 10 seconds.
<b>C+</b>	Continuous Boost Stimulation	Sends stimulation continuously up to 10 seconds.
<b>R</b>	1 Second Ramp Stimulation	Stimulation ramps from 10 to stimulation level
<b>R+</b>	2 Second Ramp Boosted Stimulation	Stimulation ramps from 10 to boosted stimulation level
<b>I</b>	Instant Stimulation Mode	Gives Continuous Stimulation up to 45 seconds follows by Volume Dial Volume Dial must be 0 to activate
<b>V</b>	Vibration	Vibrate up to 30 seconds
<b>T</b>	Tone	Flat sound up to 30 seconds
<b>+</b>	Boost Level Setting	Set up Boost Level. Default is 5
	Night Tracking Light	Turn ON/OFF Night Tracking Receiver Light
	Lost Transmitter	6 Hours Timer for Transmitter
	Pairing Collar Receivers	Replace/Add Receivers
<b>1 2 3</b>	Multi Dog System Indicator	Display current Dog system
<b>88</b>	Stimulation Level Indication	0 to 100 Stimulation Level
	Battery Indicator	Indicates Transmitter Battery Level

## PROGRAMING STIMULATION BUTTONS

---

You have the option to program any stimulation mode to the S1, S2, S3, and S4 buttons.

1. Press and hold the P button until PR is displayed.
2. Continuously press any one of S1~S4 buttons until the desired stimulation mode is displayed.
3. The stimulation mode will proceed to change accordingly :



4. Continually follow steps 1 to 3 to program the remaining buttons.
5. At any given moment, press the P button to exit the Programming mode.

# 12

## COMPUTER INTERFACE TOOL

---



With the computer interface tool, you have the ability to modify the settings on your PE 900 series E-Collar to customize it to suit your dog's unique requirements. To make adjustments to the Vibration and Tone type, you will need to utilize the computer interface tool, which is conveniently accessible for download at [www.ecollar.com](http://www.ecollar.com). Please note that this program is most compatible with windows OS and 32-bit Java.

- **Multi-Dog Selection :**  
Quick and easy selection of one, two or three dog modes.
- **Button Selection Drop downs :**  
Convenient drop down for each control button provide quick and easy selection of the desired sensation.
- **Level Lock :**  
Ability to lock the level preventing accidental over stimulation by inadvertent movement of the dial
- **Boost Level :**  
Allows the user to select a level between 1 and 60 which provides for an emergency boost of the stimulation level, great for the times when the working level is ignored by the dog due to a high distraction  
Selection of "I Mode" feature to limit the stimulation or allow full access to all 100 levels
- **Selection of Vibration – 7 Types :**
  - H High Constant Vibration
  - M Medium Constant Vibration
  - L Low Constant Vibration
  - TS-H High Tapping Sensation – 1 second on and 1 second off
  - TS-M Medium Tapping Sensation – 1 second on and 1 second off
  - TS-L Low Tapping Sensation – 1 second on and 1 second off
  - TA Two seconds of constant medium vibration followed by continuous stimulation; commonly known as Classical or Pavlovian Conditioning
- **Selection of Tone - 4 Types :**
  - H High Constant Tone
  - M Medium Constant Tone
  - L Low Constant Tone
  - PA PA Two seconds of constant medium tone followed by continuous stimulation; commonly known as Classical or Pavlovian Conditioning

## INSTANT STIMULATION

---

This unique mode eliminates the surprise of the stimulation “shock” found when applying levels above 30 to a dog in training. The stimulation can only be applied by starting at zero and turning the dial up on the dog until the desired response and/or compliance are achieved. It also is very convenient for the user as the dial only needs to be turned and no buttons need to be pushed once the “I” mode is activated.

Great for boundary training, aggressive dog aversion training, IPO sport training, and many other situations that requires precision control and pressure.

### To Program Stimulation Mode (I-Mode)

1. Press and hold the P button until PR is displayed.
2. Press any one of S1~S4 buttons repeatedly until I mode is shown.
3. Stimulation mode will change as follow :



4. Press P to exit the Programming mode.

**NOTE: I-Mode provides stimulation for up to 45 seconds or until you have dialed back down to 0 or turned off I-mode by pressing the set button again.**

1. To Use the I mode, program Instant stimulation mode to one of your stimulation buttons.
2. To activate turn dial to 0 and press button set to I mode. You will see [ On ] icon.
3. Turn Volume Dial to activate stimulation. Stimulation increases/decreases as dial is rotated.
4. Stimulation will automatically shut down after 45 seconds. Change stimulation level to 0 level will reset the 45 seconds safety timer.
5. Press assigned Stimulation Button to turn off Instant Stimulation.

# 14

## HOW TO FIND THE PROPER STIMULATION LEVEL

---

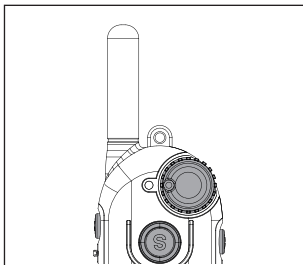

Rotating the dial counter-clockwise increases the stimulation level, and rotating the dial clockwise lowers the stimulation level.

It is highly recommended that the user practices changing levels and modes before putting the collar receiver on a dog.

Setting the correct stimulation level for your dog is very important. To set your "conditioning" stimulation level, correctly put the collar receiver on your dog (see page 9 for instructions). Let the dog get used to the collar receiver for a couple of hours.

While watching your dog, turn the level to "0" and press the continuous stimulation button. Slowly turn the stimulation up at a rate of approximately 2-3 levels per second. When your dog first perceives the stimulation, usually between 5 and 20, release the button. This is your "conditioning" stimulation level. You may need to increase the "conditioning" level a few levels to get your dog to respond at first, some dogs are more stubborn and need more stimulation. The boosted level is typically 5 to 20 levels higher than the "conditioning" level.

## LOOK/UNLOOK THE STIMULATION LEVEL

---

Lock the stimulation level to protect from unexpected high level stimulation.

1. Press and hold the P button until **PR** is displayed.
2. Press any one of S1~S4 buttons repeatedly to select either M or C.
3. Use volume dial to change stimulation level to desired level to lock.
4. Press and hold same stimulation button until 1 icon on LCD changes from blinking to solid.
5. Press P button to exit from the Programming Mode.
6. Repeat step 1 - 5 to unlock the stimulation level.

**Important Notice** : When Simulation is locked, Stimulation level will not change when the button is pressed even though the displayed stimulation may change.

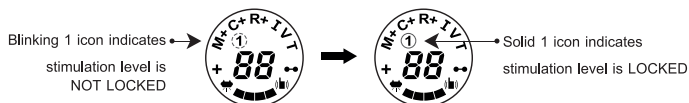



# 16

## Tracking Night Light

---

The Pro 900 E-Collar offers a Tracking Night Light feature, allowing the user to choose between a constant bright light or a flashing bright light on the dog's collar receiver. This feature enhances visibility around the dog and helps to track their movements more easily at night.

1. Press and hold the P button until the PR is displayed.
2. Press the ON/OFF button two times, check [ 🐕 ] icon at LCD.
3. Press any one of S1~S4 buttons to activate.
4. Receiver light will change OFF → Blinking → Solid, when you press S1~S4 each time.
5. Press the P button to exit the programming mode.



**Important Notice** : Exiting programming mode does not automatically disable the Night Tracking Light. Utilizing this feature can significantly drain the collar receiver's battery.

## HOW TO SET THE BOOST

---

Boosted Stimulation adds the set boost level to the stimulation level, great for those situations when your dog does not respond to the "conditioning" level. Determining the Boosted stimulation level is a little more difficult than stimulation level setting due to the wide differences in temperaments and stimulation tolerance among the many breeds of dogs. On average, it is normally 5 to 20 levels higher than the "conditioning" level. It is important to have it set high enough to get the desired response from your dog.

1. Press and hold the P button until the PR is displayed.
2. Press the ON/OFF button once and verify the [ + ] icon on the LCD.
3. Use the volume dial to adjust to the desired boost level and press S1 to save.
4. Press the P button to exit the programming mode.

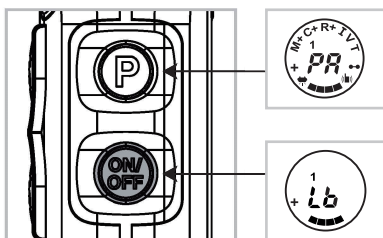

# 18

## LOST TRANSMITTER MODE

---

The Pro 900 E-Collar transmitter gives users the option to activate a timer for a duration of 6 hours. When the time is up, the transmitter will emit a beeping sound, making it easier to locate.

It is important to activate the Lost Transmitter mode before embarking on a hike or engaging in activities where misplacing the transmitter is a possibility.

1. Press and hold P button until PR is displayed.
2. Press ON/OFF button three times, check [ (🔊) ] icon on LCD.
3. Press any one of S1-S4 buttons to start alarm timer.
4. Transmitter LCD shows [ 0h ] when activated, followed by confirmation tone, and icon will remain on LCD until alarm goes OFF.
5. Press P button to exit from the programming mode.



## REPLACE/ADD COLLAR

---

Occasionally, it is necessary to pair/sync a transmitter to a collar receiver.

1  
D  
O  
G

1. Turn on the Transmitter
2. Turn intensity dial to "0"
3. Make sure the collar receiver is turned off.
4. Press and hold the P button until **PR** is displayed.
5. Press the On/Off button four times, until the  icon is on LCD.
6. Put the Transmitter's Red Dot against the Collar Receiver's Red Dot for more than 5 seconds, green light on receiver will flash rapidly.
7. Pull apart and immediately press the S1 button, you should hear a confirmation sound from collar receiver.

2  
D  
O  
G

1. Turn on the Transmitter
2. Turn intensity dial to "0"
3. Make sure the collar receiver is turned off.
4. Press and hold the P button until **PR** is displayed.
5. Press the On/Off button four times, until the  icon is on LCD.
6. Put the Transmitter's Red Dot against the Collar Receiver's Red Dot for more than 5 seconds, green light on receiver will flash rapidly.
7. Pull apart and immediately press the S1 button, you should hear a confirmation sound from collar receiver.

3  
D  
O  
G

1. Turn on the Transmitter
2. Turn intensity dial to "0"
3. Make sure the collar receiver is turned off.
4. Press and hold the P button until **PR** is displayed.
5. Press the On/Off button four times, until the  icon is on LCD.
6. Put the Transmitter's Red Dot against the Collar Receiver's Red Dot for more than 5 seconds, green light on receiver will flash rapidly.
7. Pull apart and immediately press the S1 button, you should hear a confirmation sound from collar receiver.

## MULTI DOG SYSTEM

---





The Pro 900 Educator is a versatile dog training system that can control up to 3 dogs. To switch between a 1 Dog System, 2 dog system, or 3 dog system, simply press the ON/OFF button and S1 button simultaneously.



Stimulation buttons work different while multi dog System

Stimulation Buttons	Stimulation buttons for multiple dogs		
	1 Dog System	2 Dog System	3 Dog System
S1-Button	Dog 1	Dog 1	Dog 1
S2-Button	Dog 1	Dog 2	Dog 3
S3-Button	Dog 1	Dog 1	Dog 1
S4-Button	Dog 1	Dog 2	Dog 2

## 902/903 BUTTON FUNCTIONS

Icon	Description	Action
<b>M</b>	Momentary Stimulation	Send Single Stimulation in short duration
<b>M+</b>	Momentary Boost Stimulation	Send boosted single stimulation in short duration
<b>C</b>	Continuous Stimulation	Sends stimulation continuously up to 10 seconds.
<b>C+</b>	Continuous Boost Stimulation	Sends stimulation countinuously up to 10 seconds.
<b>R</b>	1 Second Ramp Stimulation	Stimulation ramps from 10 to stimulation level
<b>R+</b>	2 Second Ramp Boosted Stimulation	Stimulation ramps from 10 to boosted stimulation level
<b>I</b>		Gives Continuous Stimulation up to 45 seconds follows by Volume Dial Volume Dial must be 0 to activate
<b>V</b>		Vibrate up to 30 seconds
<b>T</b>	Tone	Flat sound up to 30 seconds
<b>+</b>	Boost Level Setting	Set up Boost Level. Default is 5
	Night Tracking Light	Turn ON/OFF Night Tracking Receiver Light
	Lost Transmitter	6 Hours Timer for Transmitter
	Pairing Collar Receivers	Replace/Add Receivers
<b>1 2 3</b>	Multi Dog System Indicator	Display cureent Dog system
<b>88</b>	Stimulation Level Indication	0 to 100 Stimulation Level
	Battery Indicator	Indicates Transmitter Battery Level

# 22

## 902/903 BUTTON FUNCTIONS

### Programing Stimulation Buttons in a multi dog programing

You have the option to program any stimulation mode to the S1, S2, S3, and S4 buttons.

#### Default Stimulation buttons for Multi Dog System

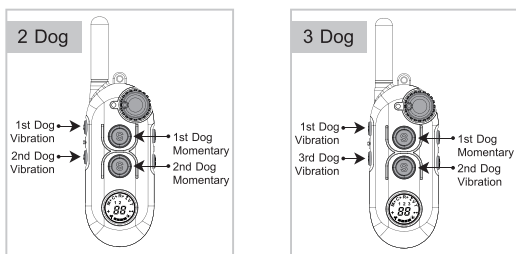

1. Depress and hold the P button until PR is displayed.
2. Continuously press any one of S1~S4 buttons until the desired stimulation mode is displayed.
3. The stimulation mode will proceed to change accordingly :



4. Continually follow steps 1 to 3 to program the remaining buttons.
5. At any given moment, press the P button to exit the Programming mode.

## 902/903 LOCK/UNLOCK THE STIMULATIONLEVEL

---

1. Press and hold the P button until **PR** is displayed.
2. Press any one of the S1~S4 buttons repeatedly to select either **M** or **C**.
3. Use the volume dial to adjust the stimulation level.
4. Press and hold same stimulation button until **1/2/3 icon** on LCD will changes from blinking to solid.
5. Press P button to exit from the Programming Mode.
6. Repeat step 1 to 5 to unlock the stimulation level.

**Important Notice** : When Stimulation is locked, Stimulation level will not change even though you change the Volume Dial

1 Dog System → 2 Dog System → 3 Dog System



Blinking 1/2/3 icon indicates  
stimulation level is NOT LOCKED



Solid 1/2/3 icon indicates  
stimulation level is LOCKED



## 902/903 BOOST LEVEL SETUP

---

### Two Button Boost

When utilizing a 2-dog or 3-dog system, there is a more convenient method for activating Boosted stimulation. Instead of adjusting the Boosted stimulation directly on the stimulation button, it can be achieved through the combination of two buttons. Please note that this particular feature is only compatible with Momentary and Continuous modes.

1. Press the stimulation button, either in a momentary or continuous.
2. Prior to releasing the stimulation button, simultaneously press either above or beneath the stimulation button for an enhanced stimulation experience.

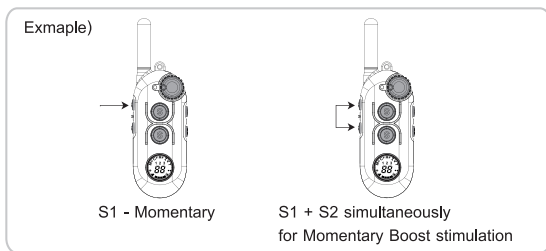

### Warning Mode

Warning Mode is an exclusive feature available only on the 3 Dog System. In this mode, the Stimulation Modes of **all** dogs will be automatically adjusted to Vibration. This feature is suggested for situations where there is limited time to switch between Stimulation modes.

1. Press the P button to activate the Warning Mode.
2. Following a single beep, all stimulation modes of S2, S3, S4, except for the tone, will switch to vibration automatically.
3. In order to exit the warning mode, simply press the P button once more.
4. After two beeps, all stimulation modes will revert back to their previous preset settings.

## TESTING YOUR E-COLLAR

---

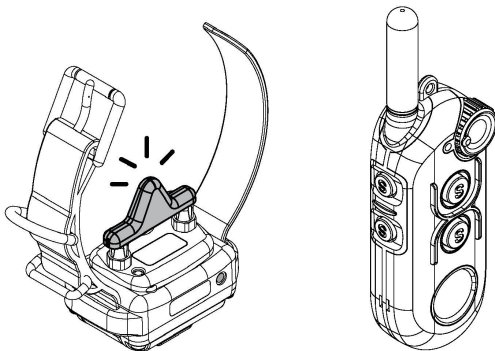

If you need to check your unit, hold the test light against the contact points on the collar receiver. This test will let you know that the collar receiver is generating the proper sensation to the dog, it should brighten in a smooth fashion as the dial is turned up.

Some people find it easier to hold the collar receiver on their forearm while slowly turning the stimulation up using the continuous mode, typically as humans we will begin to feel the simulation around a level 8 to 25 depending on the dryness of the skin.

Feel free to contact us if you have need help, 1-260-357-0051.

## REPLACING THE CONTACT POINTS

---

The standard 5/8" contact points are typically used for the majority of dogs. However, breeds with thicker fur may require the longer 3/4" contact points. To replace the 5/8" contact points, please refer to the enclosed contact point tool and follow the instructions provided.

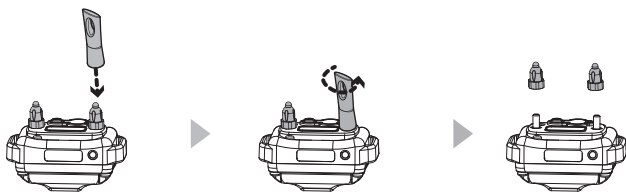

1. Loosen both contact points by rotating the contact point counter-clockwise using the contact point tool.

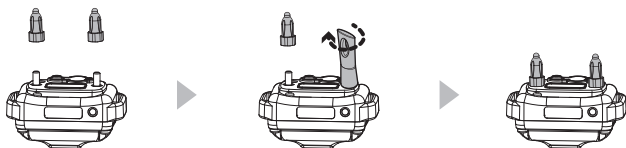

2. Install the 3/4" contact points onto the bolt and tighten the contact points by rotating them clockwise with the contact point tool.

\* For short haired breeds such as boxers, dachshund, pit bulls, etc, and thick-furred breeds, we kindly request you to visit our website or get in touch with us for information regarding special contact options for your canine companion.

**IMPORTANT TRAINING TIPS**

E-Collars can be utilized to reinforce commands that your dog already knows or as a learning tool when combined with leash pressure. It should be noted that they are not intended to replace basic leash obedience training, but rather to enhance your ability to communicate with your dog. For optimal outcomes, it is recommended to utilize the minimal amount of stimulation necessary to capture your dog's attention. A composed and consistent approach to training will consistently yield better long-term results. It is strongly advised that owners of aggressive dogs consult a professional trainer for evaluation prior to incorporating an e-collar. Various e-collar training techniques are recommended by different professional trainers. We believe that as the owner, you are best equipped to determine the most effective technique for your dog. For first-time users, we suggest immersing yourself in learning about the proper techniques or seeking the guidance of a professional e-collar trainer. The method employed in initially introducing the e-collar is crucial to the success of the training.

You can find helpful training videos by searching for E-Collar Technologies on YouTube and subscribing to our channel, as we regularly post new content. Additionally, please consider "Liking" our Facebook page to receive further training advice and connect with other e-collar users.

**Good Luck with your training from your friends at  
E-Collar Technologies**

## TROUBLESHOOTING

---

### ? My Receiver / Transmitter is not turning on

- A Make sure the Receiver has been charged. We recommend device fully charge before use.

### ? My Receiver is not responding

- A Check Receiver's indicator light is blinking green and Transmitter LCD to check device power.
- A Check Receiver's indicator light is red when you press any stimulation button.
  - A. If you don't see any red light, check your device using right Multi dog system. For example, if you have one dog, you must small **1 icon** only at "Multi Dog system Indicator" on LCD display.
  - B. If still Receiver not respond, Try pairing with Receiver one more time.

### ? I think receiver gives no stimulation at all

- A Remove Contact points from Receiver. Connect Test Light on the Receiver and try any stimulation. If the test light is blinking, receiver is giving stimulation.

### ? Max range of device has been decreased

- A Check Transmitter's battery condition. Working range decrease if battery level is too low.
- A Holding position is important; keep finger away from the antenna. Touching the antenna by finger will greatly reduce the range.

### ? I want to reset the Transmitter as default

- A Rotate Volume Dial to 0, press ON/OFF + S3 simultaneously for 6 sec.

**CONTACT US FOR EXPERT HELP WITH YOUR E-COLLAR**

## TWO YEAR WARRANTY

---

To register your product, kindly visit our website at [www.ecollar.com](http://www.ecollar.com). Click on the warranty registration link and complete the necessary information. We kindly ask that you register your product within 30 days of your purchase. If you are unable to access a computer, please feel free to contact one of our dedicated customer service representatives at 1-260-357-0051. They will be happy to assist you in registering your product. If, for any reason, your product is not registered properly, proof of purchase will not be required to obtain warranty coverage. We will be able to estimate your purchase date based on the serial number. It is important to note that misuse, improper maintenance, lost or stolen units, and dog damages are not covered under the manufacturer's warranty. We strive for your complete satisfaction and aim to provide exceptional service.

**“Making Bad Dogs Good  
and Good Dogs Better!”**

# 30

## ACCESSORIES

---

- Titanium Hypo-Allergenic Contact Pints



- Thick Fur Contact Points



- Short Point Comfort Pads



- Magnetic AnyWear Clip



- Ultra Wing Contact Point Comfort Pads



- Gear Keeper



- Bungee Collar



- Quick Snap Bungee Collar



[www.ecollar.com](http://www.ecollar.com)

## SAFETY AND GENERAL INFORMATION

---

- The PE-900 Series Education Collar complies with all National and International Standards and Guidelines for human exposure to radio frequency electromagnetic energy.
- Nearly all electronic devices are susceptible to electromagnetic interference (EMI) if inadequately shielded or designed without precautions to EMI.
- PE-900 Series e-collar transmitters manufactured by E-Collar Technologies, Inc. comply with Article 15 of the FCC rules and operate under part 95 of FCC regulations.
- Operating Frequency Band is 27.095 MHz.

### IMPORTANT NOTICE

1. To avoid Electromagnetic Interference and/or compatibility conflicts, please turn off your transmitter and collar receiver in any facility where posted notices instruct you to do so. Never use your equipment in close proximity of a Hospital or Health Care Facility or enter the facility without turning off both units.
2. An FCC license is not needed to operate PE-900 Series remote e-collar transmitters. However, any change or modification made to the transmitter, including the supplied antenna, without the expressed written approval of E-Collar Technologies, Inc. could void your authority to operate.



## IMPORTANT NOTICE

---

### **NOTICE**

#### **Possible Metal Allergy**

Dogs vary in sensitivity and may develop symptoms of a metal allergy.

Which may include irritation, redness, hair loss, sores, etc.

Please rotate collar receiver from side to side daily to check for allergies.

If allergies occur, hypoallergenic contact points are available for purchase

at [www.ecollar.com](http://www.ecollar.com) or 260-357-0051

### **NOTICE TO PREVENT WATER DAMAGE**

If Receiver is exposed to water on a regular basis, tighten screws once or twice a month depending on the frequency of water exposure.

Please make sure screws are snug but not overly tight.

This will help prevent internal water damage.

### **ITEM SHOULD BE PLACED OUT OF THE REACH OF CHILDREN**

This product is not meant to be used by individuals (including children) with limited physical, sensory, or cognitive abilities, or those lacking expertise and understanding, unless they are under the supervision or guidance of a person responsible for their safety. This also applies to the cleaning and upkeep of the item.

The item should exclusively be used with the power supply (charger) provided with the product.

## TECHNICAL SPECIFICATIONS

Transmitting and receiving standard frequency	27 Mhz
Operating range (maximum effective range of open space)	1/2 mile range
Degree of protection	IP68
Transmitter battery (Li_Po)	720mAh
Collar Receiver battery (Li_Po)	300mAh
Battery voltage	3.7V ~ 4.2V
Charging voltage	5V
Time for battery fully charged	1-2 Hours
Collar Receiver Battery Life (Standby mode)	24 ~ 48 Hours
Transmitter Battery Life (Standby mode)	Battery last more then 1 week
Working temperature	0 ~ 55°C
Storage temperature / Humidity	-40 ~ 85 °C / 30%
<p>"Risk of fire or explosion if the battery is replaced by an incorrect type"            "Use an adapter that satisfies PS2 or LPS"</p>	



# E-Collar Technologies, Inc.

2120 Forrest Park Drive  
Garrett, IN 46738-1887  
1-260-357-0051 (US & International)

**sales@ecollar.com**  
**www.ecollar.com**  
**customerservice@ecollar.com**



*Thank you for Supporting American Workers*

Copyright 2015 E-Collar Technologies, Inc.

All Rights Reserved.