



Easy Educator EZ-903/904

Quick Start Guide

E-Collar Technologies, Inc.

Welcome

Thank you for trusting us with your purchase of the 903/904 Easy Educator Remote Education Collar. We have made every attempt to provide you with the most technologically advanced product using the most stringent quality and manufacturing standards.

We are confident you will be pleased with the results you will attain with the 903/904 Easy Educator. Please remember you will get better results with the use of low level stimulation combined with consistent training techniques. The use of high levels of stimulation should only be used as a last resort and in life-threatening situations.

Good luck with your training and please feel free to contact us should you have any questions.

* This guide will familiarize you with the basic functions, programming features and the contents of the 903/904 Easy Educator. Additional information and help is available on www.ecollar.com and by e-mailing customerservice@ecollar.com. Please contact our customer service (260) 357-0051.

TABLE OF CONTENTS

- Characteristics 3
- Package Contents 4
- Turning ON/OFF the EZ-903/904 System / Charging Instructions 5
- Correctly Fitting Collar 6
- LCD Display 4Dog Mode 8
- Buttons Descriptions and Stimulation Button Assignments 9
- I Mode 12
- Lock and Unlock Stimulation Level 13
- Boosted Level Setup 15
- Lost Transmitter Activation 17
- Pairing/Syncing 18
- Mode Toggle Feature 20
- EZ-903/904 Four Dog Default Settings 21
- Warranty and Registration 22
- Safety and General Information 24
- Important Information 25

CHARACTERISTICS

- 1/2 mile Range
- Employs Quick Charge Li-Polymer Batteries
- Convenient Intensity Dial for Quick Adjustment
- Stimulation Levels Adjustable from 0 to 100
- Collar Receiver Light for Night Tracking
- “Lock and Set” Stimulation Safety Feature
- User Adjustable Boosting Levels
- Patented “I” Mode Provides Instant Stimulation
- Waterproof and Shock Resistant
- Specific Control Button for Each Dog

04

PACKAGE CONTENTS

- Four Dog Transmitter/ Remote Controller

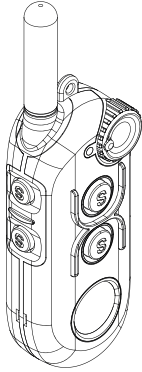

- Waterproof Collar Receiver on High Quality Biothane Strap

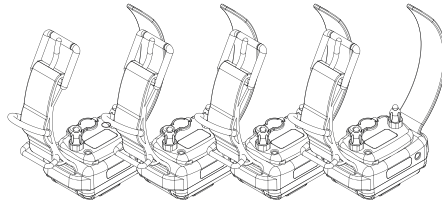

- Quick Start Owner's Guide

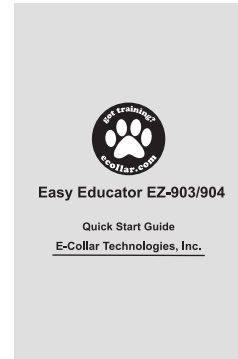

- Test Light

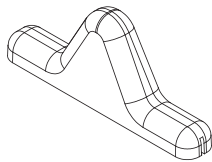

- Contact Point Tool



- 1/2" and 3/4" Contact Points - 4 Sets

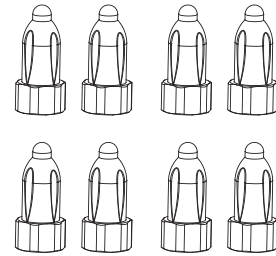

- Lanyard

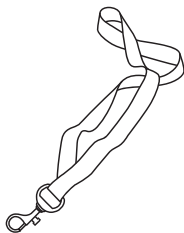

- Battery Chargers

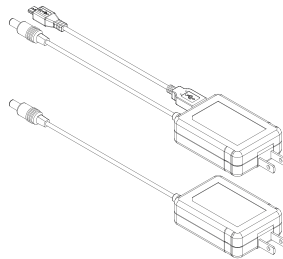

- Splitter Cables

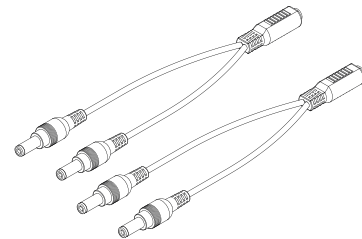

Turning ON/OFF the EZ-903/904 System

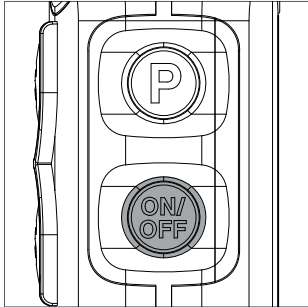

Turn ON/OFF the transmitter by pressing and holding the lower right button for 1 to 3 seconds.

To turn ON/OFF the collar receivers position the small red dot on the transmitter/remote on the red dot on the collar receiver for 1 to 3 seconds.

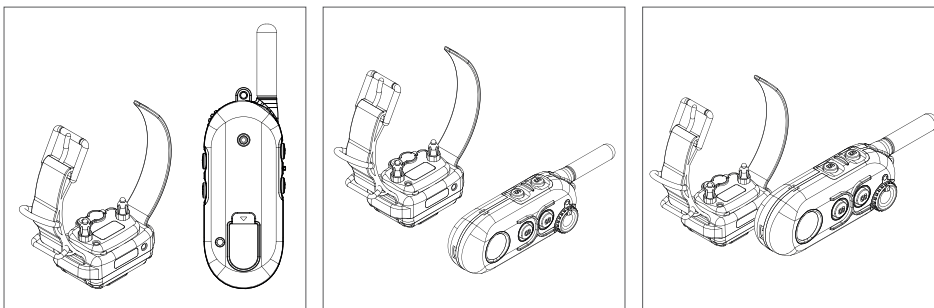

Charging Instructions

Please charge the units on or before the low battery indication. It is best not to wait until the batteries are fully drained to avoid damage. To charge insert the micro USB into the transmitter and the charge plug into the collar receiver as pictured. Store with 50% charge in cool dry place.

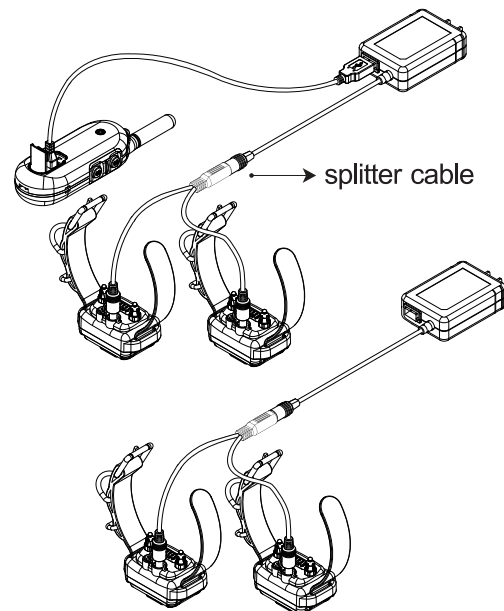

Low Battery Indication

Transmitter : One bar remaining on the LCD display indicates charging is needed.

Collar Receiver : Yellow light indicates low and red indicates very low battery life.

06

Correctly Fitting Collar

Proper fit and position of the Receiver is important for better training efficiency

Caution

To prevent the occurrence of skin irritations, the collar receiver should not be worn for more than 10-12 hours per day and should be rotated every few hours.

Dogs should never sleep with it on overnight or in their kennel.

The dogs skin needs to be conditioned to the contact points this is accomplished by starting out with 1 to 2 hours and slowly working up to the absolute maximum of 12 hours per day.

Should your dog experience skin irritations from over exposure to the contact points or allergic reaction to the nickel remove the collar receiver unit immediately and stop using your e-collar until the skin irritations are totally healed. Antibiotic ointment is suggested to aid in the healing process and prevent infections, a visit to your Veterinarian may be required should any open sores become infected.

The collar should be adjusted to allow the “contact points” to have direct contact with the skin. You should be able to fit a couple of fingers between the collar strap and your dog. Too tight poses the risk of skin irritation and discomfort. Too loose and the contact points will not be able to administer the stimulation reliably and can cause skin irritation due to chafing. A nice snug fit is best.



Always seat the collar receiver by giving it a little wiggle to remove any hair that is between the contact points and the dog's skin.

The optimal position for the collar receiver is on either side of the dog's windpipe in the 2 to 5 or the 7 to 10 o'clock position; most dogs don't like it on their windpipes.

Periodically switching positions during a full day of e-collar use is good practice and can help prevent irritations from occurring. Inspecting the area is very important to assure your dog is handling the pressure from the contact points.

How to Change the Contact Points

If the 1/2" factory installed contact points do not make good contact due to long hair, you can easily change to 3/4" contact points with the contact point tool. Follow diagrams step by step. Very long and thick coats require special contact points, available for purchase on ecollar.com

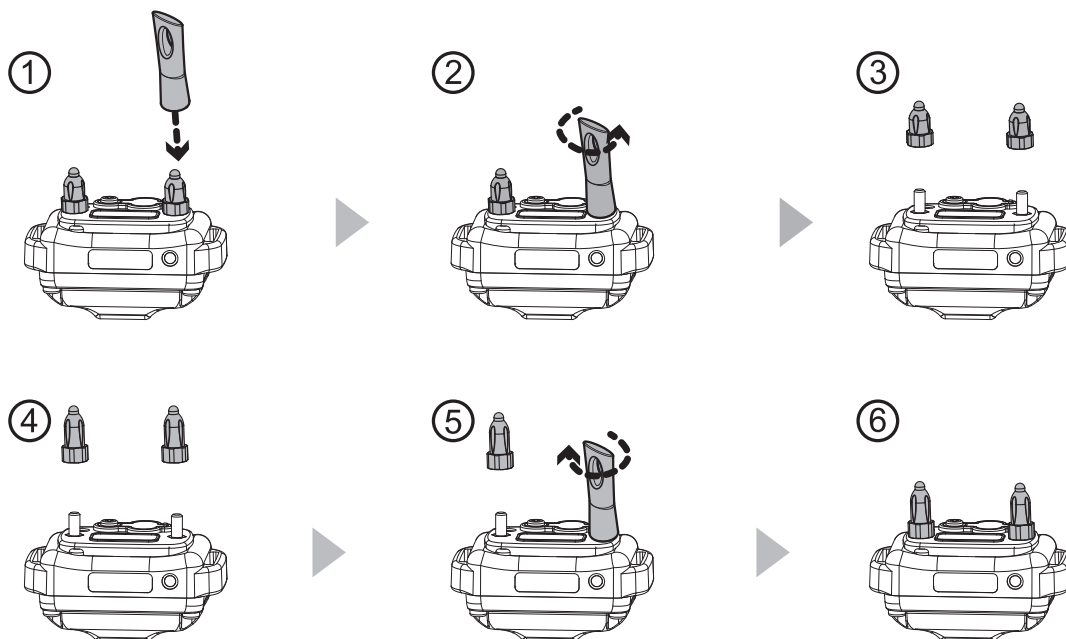

08

LCD DISPLAY 4 DOG Mode

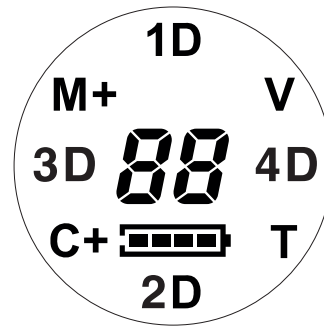

Icon	Description	Remarks
M	Momentary Stimulation	Short Pulse of Stimulation
M+	Momentary Boost Stimulation	Short Pulse of Boosted Stimulation
C	Continuous Stimulation	Up to 10 Seconds of Stimulation
C+	Continuous Boost Stimulation	Up to 10 Seconds of Boosted Stimulation
I	Instant Stimulation Mode	Stimulation Level Displayed on the LCD, Must Start at "0"
V	Vibration	Non Stimulation Sensation Similar to a Vibrating Cell Phone
T	Tone	Audible Tone
Number	Stimulation Level	0 to 100 (HI) Level

Button Descriptions and Stimulation Button Assignments

The 903/904 Easy Educator has 4 control buttons which can be assigned to stimulate, vibrate or produce a tone. S1 is programmed for Dog 1, S2 is for Dog 2, S3 is for Dog 3, and S4 is for Dog 4. It also has 2 program buttons (right side) for changing modes and turning the unit ON and OFF. The convenient dial provides for easy and sight free control of the stimulation level.

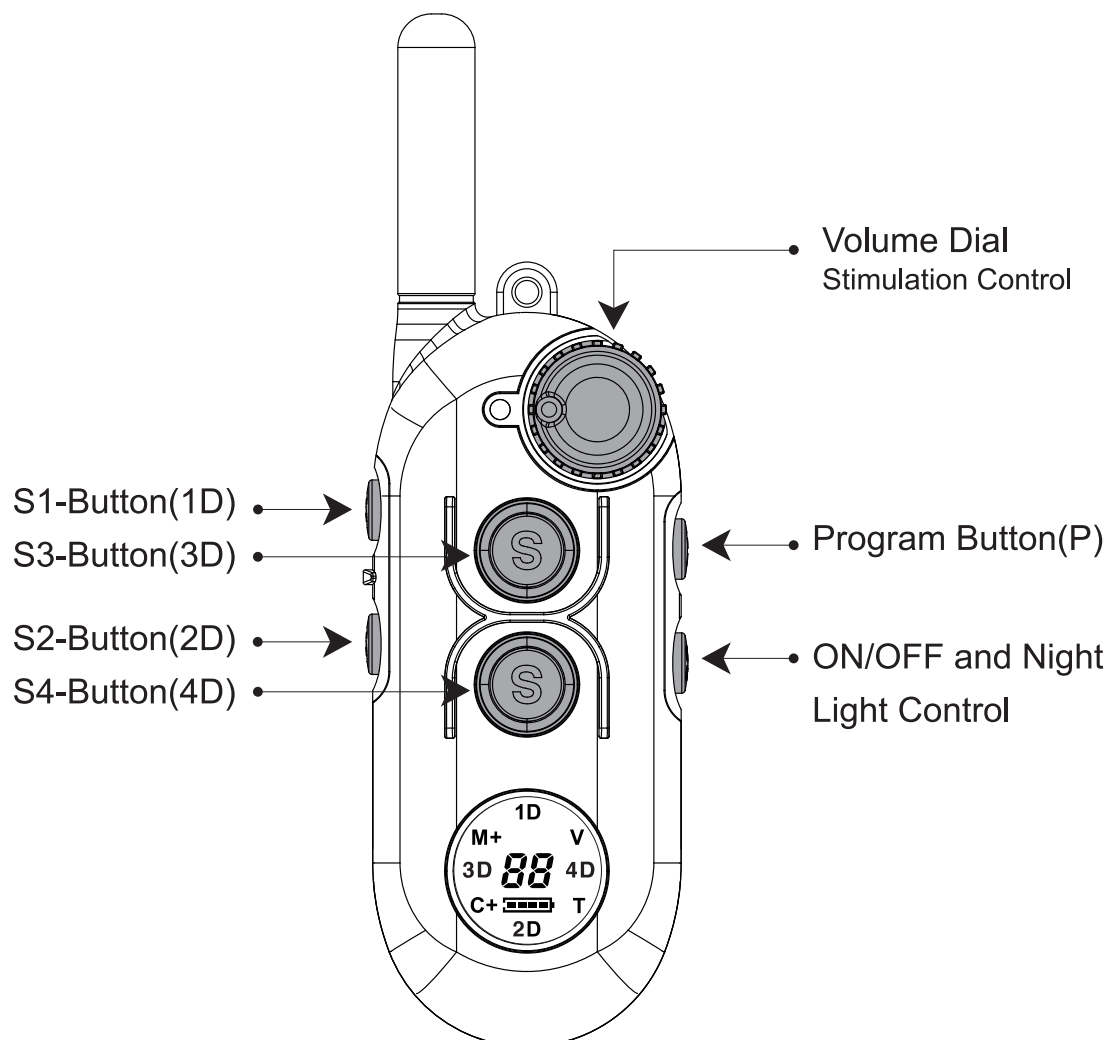

10

Program Buttons	Function	Description
ON/OFF	Power ON/OFF	Press more than 1 sec to turn on Press more than 2 sec to turn off
	Night Lights	When Stimulation Level is Not 0 1D light : ON/OFF + S1 2D light : ON/OFF + S2 3D light : ON/OFF + S3 4D light : ON/OFF + S4 (toggling : blink→solid→off)
P	Stimulation Lock	1D Volume lock : P+S1 (more than 1 sec) 2D Volume lock : P+S2 (more than 1 sec) 3D Volume lock : P+S3 (more than 1 sec) 4D Volume lock : P+S4 (more than 1 sec)
	Mode Buttons	When Stimulation level is set to "0" S1(Dog1) mode change : P+S1 (M→C→V→T) S2(Dog2) mode change : P+S2 (M→C→V→T) S3(Dog3) mode change : P+S3 (M→C→V→T) S4(Dog4) mode change : P+S4 (M→C→V→T)
	Vibration Mode	If pressed one time, all Momentary and Continuous stimulation will be changed to Vibration. To exit from Warning Mode, press P button again.

Control Buttons	Function Possibilities			
	1Dog	2Dog	3Dog	4Dog
S1-Button	M / C(I) / V / T			
S2-Button		M / C(I) / V / T		
S3-Button			M / C(I) / V / T	
S4-Button				M / C(I) / V / T
LCD Display	M / C / V / T / 1D / 2D / 3D / 4D			
Boost Function	Dog 1 Boost S1+S2	Dog 2 Boost S2+S1	Dog 3 Boost S3+S4	Dog 4 Boost S4+S3
	It is only activated when first button is M or C			

* Instant Mode should be activated using the computer interface tool

1. To start Instant mode, rotate volume to level 0 and press continuous button
2. To exit from Instant mode, press any button or wait for 45 sec.

12

I Mode

“I” Instant Stimulation Mode

The “I” mode is a patented feature which allows the stimulation to increase gradually as determined by the user. The gradual introduction of stimulation provides a more gentle sensation and removes the startling effect sometimes associated with applying a constant level of stimulation. The dog produces less cortisol and learns to avoid the higher levels by responding quickly to the command. The user has the flexibility of increasing the stimulation fast if the situation warrants a quick response from the dog.

To use Instant Stimulation Mode, it should be activated by computer program.

How Instant Stimulation “I” Mode Works

1. Change the mode of any S button to Continuous if not already programmed to “C” mode : The stimulation dial must be turned to “0” to enter the “I” mode
2. To start the “I”, press the assigned Continuous button. The display will flash On to indicate it is on and ready to begin stimulation.
3. Turning the stimulation will now activate the stimulation at the setting of the dial and continue for 45 seconds.
Returning to “0” will reset the 45 second safety timer.
4. If you do not rotate the dial for 45 seconds the “I” mode will turn off and the control button will need to be pushed again.
5. Pushing any of the other control buttons will turn off the “I” mode and therefore require the “I” mode control be pushed again to reactivate it.
6. Again, to exit the Instant Mode, press any control button or wait for 45 seconds.

Lock and Unlock Stimulation Level

Lock and Unlock Stimulation Level for Dog 1

1. Check LCD display to confirm 1D icon is blinking.
2. Set the desired stimulation to be locked by rotating the volume dial.
3. Press P and S1 simultaneously and hold for one second to lock.
4. Check LCD display to confirm 1D icon changes from blinking to solid
5. To unlock, press P button and S1 simultaneously and hold for one second.
6. Check LCD display to confirm 1D icon changes solid to blinking.

Lock and Unlock Stimulation Level for Dog 2

1. Check LCD display to confirm 2D icon is blinking.
2. Set the desired stimulation to be locked by rotating the volume dial.
3. Press P and S2 simultaneously and hold for one second to lock.
4. Check LCD display to confirm 2D icon changes from blinking to solid
5. To unlock press P button and S2 simultaneously and hold for one second.
6. Check display to confirm the 2D icon changes from solid to blinking.

Lock and Unlock Stimulation Level for Dog 3

1. Check LCD display to confirm the 3D icon is blinking.
2. Set the desired stimulation to be locked by rotating the volume dial.
3. Press P and S3 simultaneously and hold for one second to lock.
4. Check display to confirm the 3D icon changes from blinking to solid
5. To unlock press P button and S3 simultaneously and hold for one second.
6. Check display to confirm the 3D icon changes from solid to blinking.

Lock and Unlock Stimulation Level for Dog 4

1. Check LCD display to confirm the 4D icon is blinking.
2. Set the desired stimulation to lock by rotating the volume dial.
3. Press P and S4 simultaneously and hold for one second to lock.
4. Check display to confirm the 4D icon changes from blinking to solid
5. To unlock press the P button and S4 simultaneously and hold one second.
6. Check display to confirm the 4D icon changes from solid to blinking.

**Important Note: Blinking "1D", "2D", "3D", or "4D" Indicates Unlocked
Solid "1D", "2D", "3D", or "4D" Indicates Locked*

Boosted Level Setup

Boost Level Setup for Dog 1

1. Change the mode of S1 button to Momentary if not already programmed to “M” mode.
2. Change the Stimulation level to “0”
(Stimulation level should be unlocked)
3. Press Momentary button for more than 5 sec to enter into Boosted Level Change Mode.
4. Check LCD displays M+ or C+ icon
5. Rotate the dial to change the booster level. (The range of boosted level is from 1 to 60, default is 5)
6. Press the Momentary Button again to exit from Boosted Level Change Mode.

Boost Level Setup for Dog 2

1. Change the mode of S2 button to Momentary if not already programmed to “M” mode.
2. Change the Stimulation level to “0”
(Stimulation level should be unlocked)
3. Press Momentary button for more than 5 sec to enter into Boosted Level Change Mode.
4. Check LCD displays M+ or C+ icon
5. Rotate the dial to change the boosted level. (The range of boosted level is from 1 to 60, default is 5)
6. Press the Momentary Button again to exit from Boosted Level Change Mode.

Boost Level Setup for Dog 3

1. Change the mode of S3 button to Momentary if not already programmed to “M” mode.
2. Change the Stimulation level to “0”
(Stimulation level should be unlocked)
3. Press Momentary button for more than 5 sec to enter into Boosted Level Change Mode.
4. Check LCD displays M+ or C+ icon
5. Rotate the dial to change the boosted level. (The range of boosted level is from 1 to 60, default is 5)
6. Press Momentary Button again to exit from Boosted Level Change Mode.

Boost Level Setup for Dog 4

1. Change the mode of S4 button to Momentary if not already programmed to “M” mode.
2. Change the Stimulation level to “0”
(Stimulation level should be unlocked)
3. Press Momentary button for more than 5 sec to enter into Boosted Level Change Mode.
4. Check LCD displays M+ or C+ icon
5. Rotate the dial to change the boosted level. (The range of boosted level is from 1 to 60, default is 5)
6. Press Momentary Button again to exit from Boosted Level Change Mode.

Lost Transmitter Activation

**Lost Transmitter Activation (6 hours timer) : ON/OFF (Bottom Right)
plus P (Top Right)**

1. Change the Stimulation level to “0”
2. Press ON/OFF button and then press P button simultaneously.
3. One short beep will sound confirming the activation of the locator timer.
4. To deactivate, press ON/OFF button and P button one more time.
5. Two short beeps will sound confirming the deactivation of the locator timer.
6. The transmitter will start beeping exactly 6 hours from activation so plan your excursion accordingly.

Pairing/Syncing

When you want to replace the transmitter or collar receiver with a new transmitter or collar receiver it needs to be paired to existing one.

Pairing for Dog 1 (ON/OFF + S1)

1. Turn on the Transmitter.
2. Rotate the intensity dial to "0".
3. Turn off the collar receiver. Put the red dot on the transmitter against the red dot on the collar receiver for more than 5 seconds until the solid green light starts blinking on and off rapidly.
4. Press the ON/OFF button and then press the S1 button (Side Top) simultaneously.
5. Listen for confirmation sound from the Collar Receiver.
6. Test the collar receiver to make sure it accepted the new transmitter pairing/syncing code.

Pairing for Dog 2 (ON/OFF + S2)

1. Turn on the Transmitter.
2. Rotate the intensity dial to "0".
3. Turn off the collar receiver. Put the red dot on the transmitter against the red dot on the collar receiver for more than 5 seconds until the solid green light starts blinking on and off rapidly.
4. Press the ON/OFF button and then press the S2 button (Side Bottom) simultaneously.
5. Listen for confirmation sound from the Collar Receiver.
6. Test the collar receiver to make sure it accepted the new transmitter pairing/syncing code.

Pairing for Dog 3 (ON/OFF + S3)

1. Turn on the Transmitter.
2. Rotate the intensity dial to "0".
3. Turn off the collar receiver. Put the red dot on the transmitter against the red dot on the collar receiver for more than 5 seconds until the solid green light starts blinking on and off rapidly.
4. Press the ON/OFF button and then press the S3 button (Front Top) simultaneously.
5. Listen for confirmation sound from the Collar Receiver.
6. Test the collar receiver to make sure it accepted the new transmitter pairing/syncing code.

Pairing for Dog 4 (ON/OFF + S4)

1. Turn on the Transmitter.
2. Rotate the intensity dial to "0".
3. Turn off the collar receiver. Put the red dot on the transmitter against the red dot on the collar receiver for more than 5 seconds until the solid green light starts blinking on and off rapidly.
4. Press the ON/OFF button and then press the S4 button (Side Bottom) simultaneously.
5. Listen for confirmation sound from the Collar Receiver.
6. Test the collar receiver to make sure it accepted the new transmitter pairing/syncing code.

Mode Toggle Feature

Switch from Stimulation to Vibration/Tone by Pressing the “P” (Upper Right) Button

EZ-903/904 provides special a convenient feature to allow for easy/quick use of stimulation with a 2 button boost and vibration/tone for all four dogs or how many dogs you are training at any given time.

To toggle the mode from the Momentary or Continuous stimulation (default is “M”) simply press the “P” button one time and listen for the unique short beep signaling that all the control buttons (S1 - S4) be changed to vibration/tone, vibration is the default non stimulation mode. If you want to use tone please refer to the mode section on page 9 to change any of the dogs from the default settings

To change back to the stimulation modes simply press P button again. The unique 2 button beep sound indicates you are back in stimulation mode. Play with this feature until you feel confident before using the Easy Educator on your dogs, the “M” and “C” icon will be appear again.

EZ-903/904 Four Dog Default Settings

Factory default setting of EZ-903/904 is as below. You can change Tone Mode, Vibration Mode, and Instant Mode by using computer interface tool which can be downloaded at <http://www.ecollar.com> under EZ-904 product description.

Factory Default Setting	
S1-Button	1D Momentary
S2-Button	2D Momentary
S3-Button	3D Momentary
S4-Button	4D Momentary
Boost Level	5
Tone Mode	Tone - Type 2
Vibration Mode	Vibration - Type 4
Instant Mode	Normal Mode

Advanced Features Available via the Computer Interface Tool

Using a microsoft based computer program, the type of tone and vibration can be changed. Also, a maximum stimulation for each dog can be set. Visit www.ecollar.com to download the tool.

Warranty and Registration



To register your Easy Educator please select one of the following procedures

(1) Go to the "All Products" section on www.ecollar.com and click the "Product Registration" tab and complete the form

(2) Call us at (260) 357-0051 and one of our customer service representatives will register your products for you, please have your serial number available.

Two Year Full Warranty:

Your product is covered by our full two year warranty.

During the warranty period we will repair and or replace your product for any reason due to workmanship and component failures. Dog chews and misuse are not covered by the warranty and are subject to a repair/ replacement fee.

NOTICE**Possible Metal Allergy**

Dogs vary in sensitivity and may develop symptoms of a metal allergy.

Which may include irritation, redness, hair loss, sores, etc.

Please rotate collar receiver from side to side daily to check for allergies.

If allergies occur, hypoallergenic contact points are available for purchase

at www.ecollar.com or 260-357-0051

NOTICE TO PREVENT WATER DAMAGE

If Receiver is exposed to water on a regular basis, tighten screws once or twice a month depending on the frequency of water exposure.

Please make sure screws are snug but not overly tight.

This will help prevent internal water damage.

This product is covered by various patents including but not limited to patents 8757098 and 8833309. Patent is pending on the Instant Stimulation Feature on this device.

Copyright 2014 E-Collar Technologies, Inc. All Rights Reserved.

Safety and General Information

- The EZ-903/904 Series Collar complies with all National and International Standards and Guidelines for human exposure to radio frequency electromagnetic energy.
- Nearly all electronic devices are susceptible to electromagnetic interference (EMI) if inadequately shielded or designed without precautions to EMI.
- EZ-903/904 Series e-collar transmitters manufactured by E-Collar Technologies, Inc. comply with Article 15 of the FCC rules and operate under Part 95 of FCC regulations.
- Operating Frequency Band is 27.095 MHz.

1. IMPORTANT NOTICE

To avoid Electromagnetic Interference and/or compatibility conflicts, please turn off your transmitter and collar receiver in any facility where posted notices instruct you to do so. Never use your equipment in close proximity of a Hospital or Health Care Facility or enter the facility without turning off both units.

2. An FCC license is not needed to operate EZ-903/904 Series e-collar transmitters. However, any change or modification made to the transmitter, including the supplied antenna, without the expressed written approval of E-Collar Technologies, Inc. could void your authority to operate.

IMPORTANT INFORMATION

About Contact Points :

Many dogs in our modern society have developed sensitivity to nickel which is a metal in all stainless steel products. Keep a watchful eye on your dogs skin where the contact points are touching his/her skin for redness or any signs of irritation. This should be done hourly at first and slowly transition to once every four hours after a month of daily wearing of the e-collar. At first notice of redness immediately switch to one of our hypo allergenic contact points, we offer both nickel free stainless steel and titanium contact points. Dogs with sensitive skin and certain breeds with known skin sensitivities like Pit Bull Terriers and Boxers should be switched early in the process as a precautionary move.



Nickel Free Stainless Steel



Available at www.ecollar.com

Accessories



Anywear Magnetic Clip



Dummy Collars



Bungee with Quick Connect



Gear Keeper Remote Holder

Many more available on www.ecollar.com



E-Collar Technologies, Inc.

**2120 Forrest Park Drive
Garrett, IN 46738-1887**

**1-260-357-0051 (US & International)
sales@ecollar.com**

www.ecollar.com

patents pending

2014 E-Collar Technologies, Inc.



Thank you for Supporting American Workers